

EKG Cable & Accessories





Compatibility: Major brands EKG devices

Compliance with
ANSI/AAMI EC53: 1998(R)2001
EN 60601-1:1990
ISO10993: 1-5,-10-2003E



FDA 510K clearance

Specification:

Cable material	TPU Jacket, Light gray		Connector	Nylon plug & Golden plated pins
Main Cable length	2.5m		Lead wire length	1.2m(limb lead); 0.8m(Chest lead)
Product name	Photo	PN Example	Reference to part number	
One piece Cable (Fixed Cable)		E10R-HP1-B/I (Example)	E: EKG diagnostic cable or lead wire 10: 10-lead(12=12 lead) R: built in resisters for protection(default: no resisters) HP: Philips/HP, factory/model code 1: Connector configure; B: banana end (N= needle, P=grabber, S=snap) I: IEC code (Default is AHA code)	
Trunk Cable		E10R-MQ1/I (Example)	E: EKG diagnostic cable or lead wire 10: 10-lead(12=12 lead) R: built in resisters for protection(default: no resisters) MQ: GE Marquette, factory/model code 1: Connector configure (default: only one connector available) I: IEC code (Default is AHA code)	



<p>Lead wire set</p>		<p>MQ10-LB/I (Example)</p>	<p>MQ: Marquette, factory/model code 10: 10: 10-lead(12=12 lead) L: lead wires B: banana end (N= needle, P=grabber, S=snap) I: IEC code (Default is AHA code)</p>
----------------------	---	--------------------------------	--

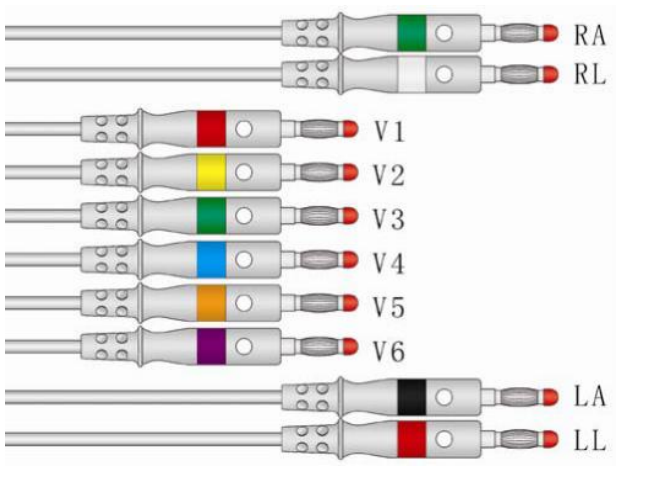
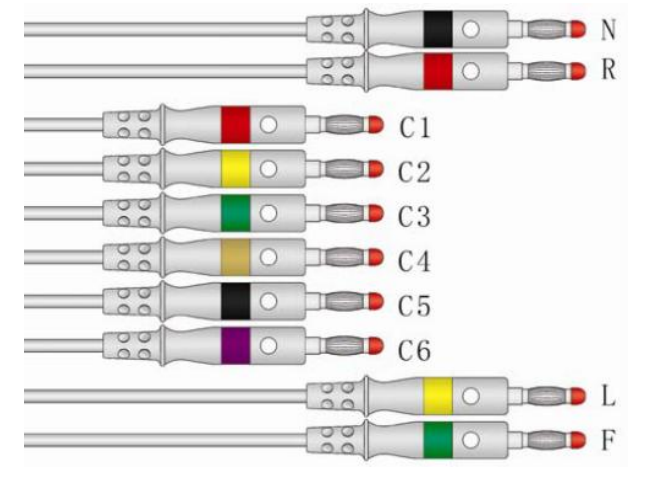
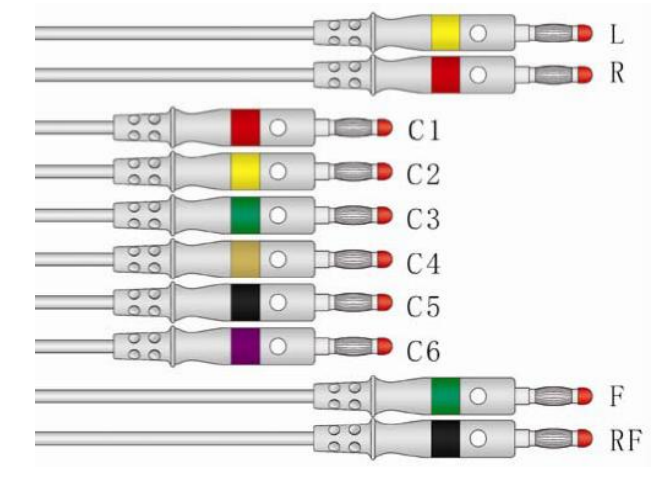

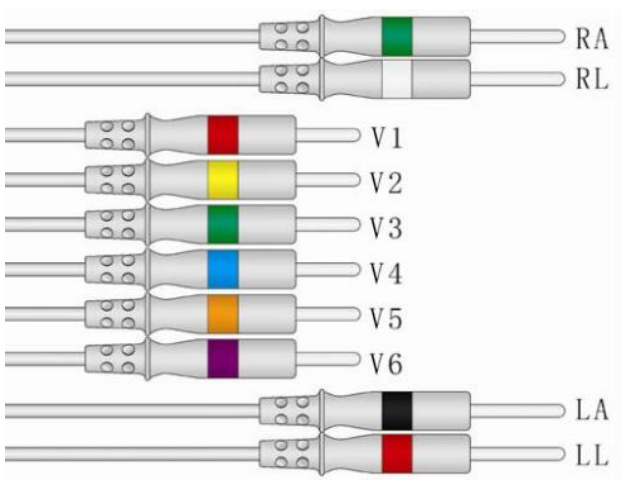
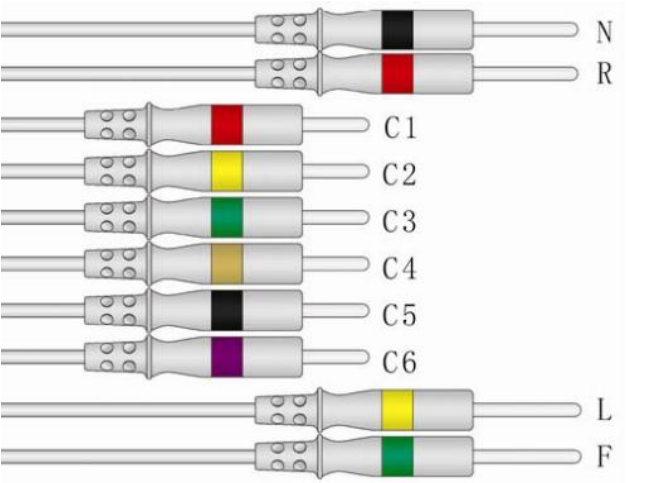
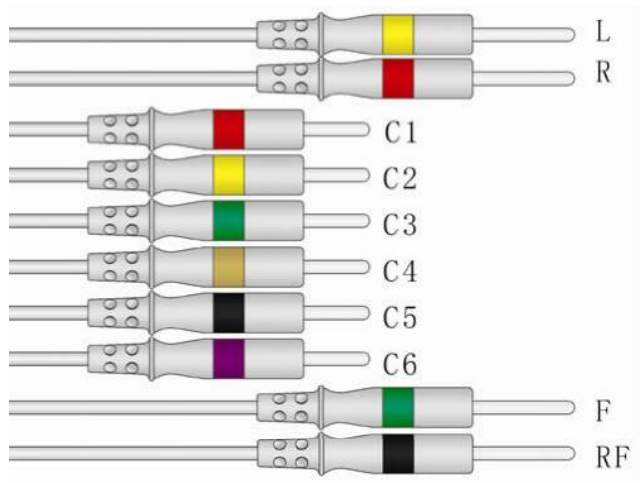
All one piece cable or lead wires are available with banana end, needle end, grabber end and snap end

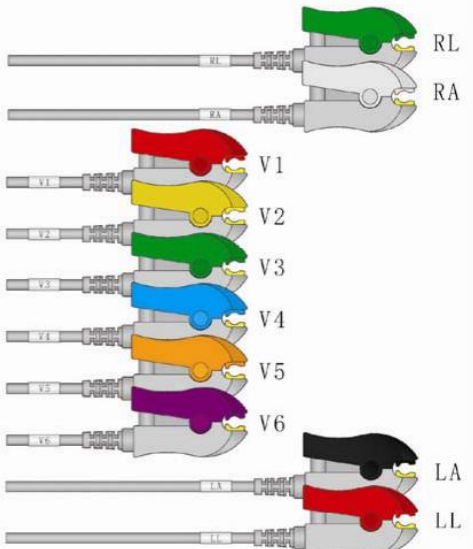
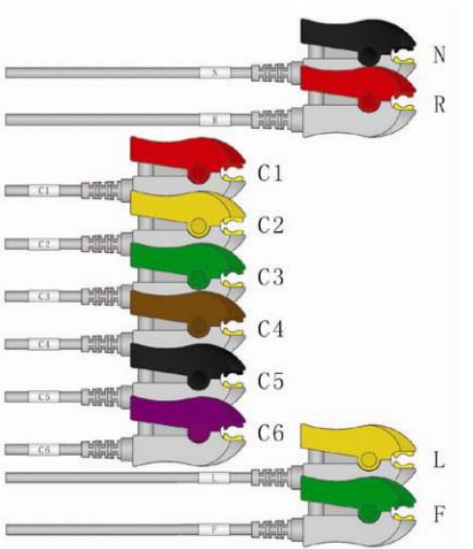
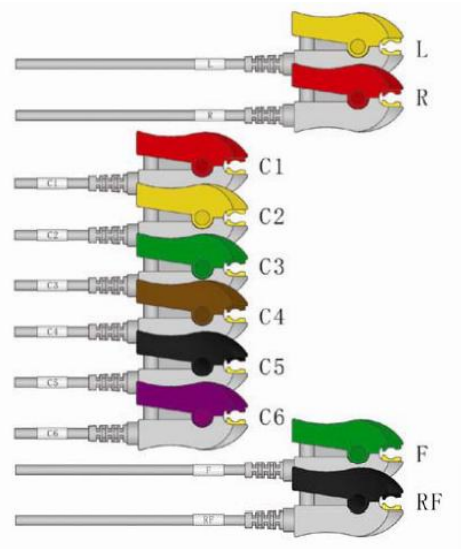
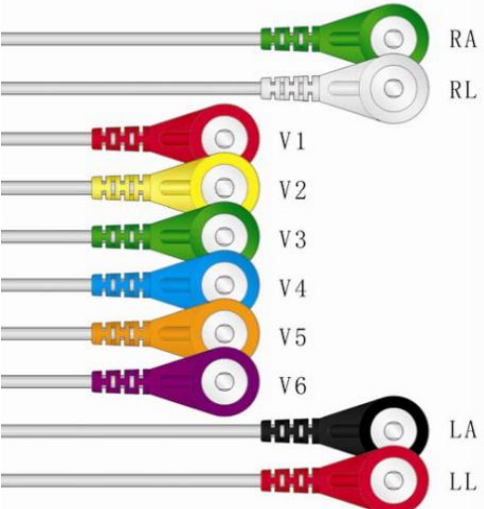
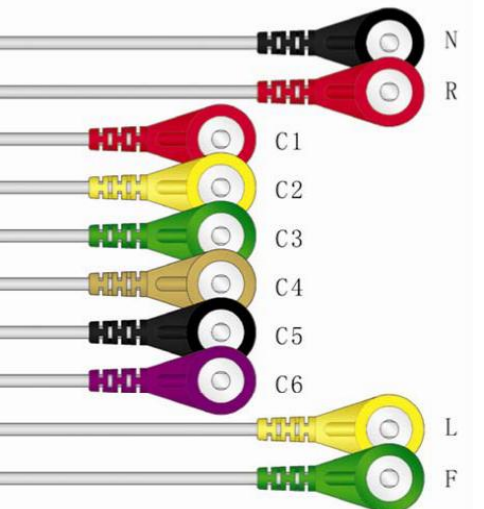
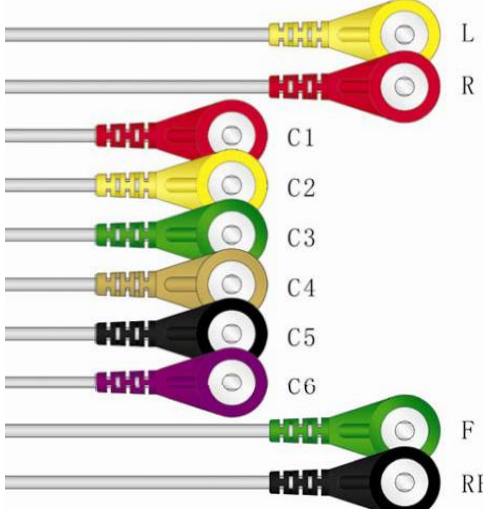
Code	AHA	IEC	IH
<p>4mm Banana end (B)</p>			

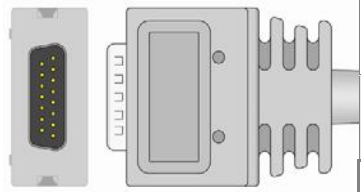
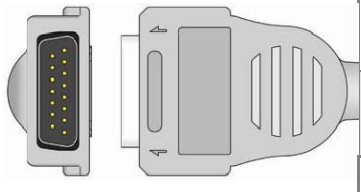
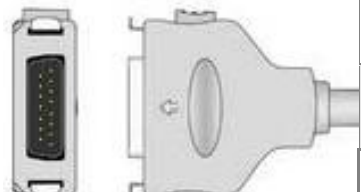

<p>3mm Needle end (N)</p>			
<p>Code</p>	<p>AHA</p>	<p>IEC</p>	<p>IH</p>

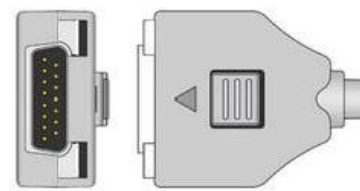
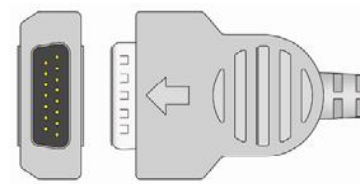
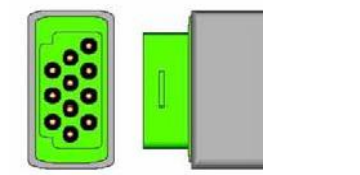

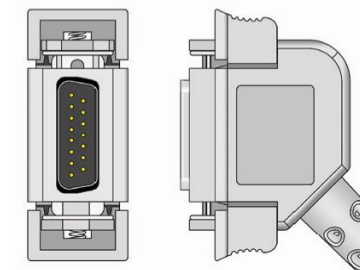
<p>Grabber End (P)</p>			
<p>Snap End (S)</p>			

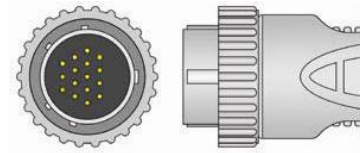
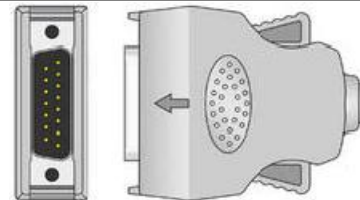
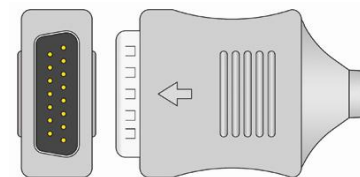
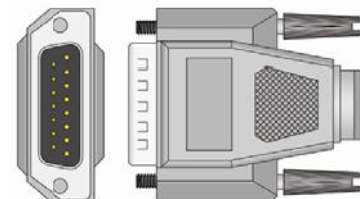
OEM & Models	EKG machine Plug	Lead No.	One piece 4mm banana	One piece 3mm needle	One piece Grabber end	Trunk Cable	4mm Lead wire	3mm Lead wire
Burdick								
EK10-E350		10	E10-BK1-B	E10-BK1-N	E10-BK1-P	N/A	N/A	N/A
			E10R-BK1-B	E10R-BK1-N	E10R-BK1-P			
		10	E10-BK1-B/I	E10-BK1-N/I	E10-BK1-P/I	N/A	N/A	N/A
			E10R-BK1-B/I	E10R-BK1-N/I	E10R-BK1-P/I			
		Price	D3	D3	D3			
Burdick Quinton Eclipse 4,8,400,800, 850,850i,plus, Eclipse LE II and ATRIA PLUS		10	E10-BK2-B	E10-BK2-N	E10-BK2-P	N/A	N/A	N/A
			E10R-BK2-B	E10R-BK2-N	E10R-BK2-P			
		10	E10-BK2-B/I	E10-BK2-N/I	E10-BK2-P/I	N/A	N/A	N/A
			E10R-BK2-B/I	E10R-BK2-N/I	E10R-BK2-P/I			
		Price	D3	D3	D3			
Fukuda Denshi								
FX101, FX102F, FX328U, FCP2201		10	E10-FD1-B	E10-FD1-N	E10-FD1-P	N/A	N/A	N/A
			E10R-FD1-B	E10R-FD1-N	E10R-FD1-P			
		10	E10-FD1-B/I	E10-FD1-N/I	E10-FD1-P/I	N/A	N/A	N/A
			E10R-FD1-B/I	E10R-FD1-N/I	E10R-FD1-P/I			
		Price	D3	D3	D3			
			Fixed Snap	Fixed grabber	Trunk cable	ECG Yoke	Snap lead	Grabber lead
		12	FD-21099S	FD-21099P	MQ-21099		MQ5-90S	MQ5-90P
							MV5-90S	MV5-90P
		12	FD-21099S-I	FD-21099P-I	MQ-21099-I	MQ5-90S-I	MQ5-90P-I	
					MV5-90S-I	MV5-90P-I		
		Price	D3	D3	D3		D1	D1

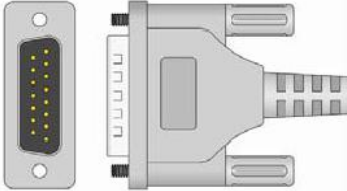
Fukuda ME								
KP-500 KP-500D		10	E10-FD2-B E10R-FD2-B	E10-FD2-N E10R-FD2-N	E10-FD2-P E10R-FD2-P	N/A	N/A	N/A
		10	E10-FD2-B/I E10R-FD2-B/I	E10-FD2-N/I E10R-FD2-N/I	E10-FD2-P/I E10R-FD2-P/I	N/A	N/A	N/A
		Price	D3	D3	D3			
GE-Marquette								
MAC 500, MAC 1100, MAC 1200		10	E10-MQ5-B E10R-MQ5-B	E10-MQ5-N E10R-MQ5-N	E10-MQ5-P E10R-MQ5-P	E10-MQ	MQ10-LB	MQ10-LN
		10	E10-MQ5-B/I E10R-MQ5-B/I	E10-MQ5-N/I E10R-MQ5-N/I	E10-MQ5-P/I E10R-MQ5-P/I	E10-MQ/I	MQ10-LB/I	MQ10-LN/I
		Price	D3	D3	D3	D3	D1	D1
Eagle, Solar, Dash monitor MAC-Lab Cath Lab Datex-Ohmeda M-Prestn & "E" modules		10-lead ECG monitoring	Fixed Snap	Fixed grabber	Trunk cable	ECG Yoke	Snap lead	Grabber lead
		12	MQ-21086S	MQ-21086P	MQ-21086		MQ5-90S MV5-90S	MQ5-90P MV5-90P
		12	MQ-21086S-I	MQ-21086P-I	MQ-21086-I		MQ5-90S-I MV5-90S-I	MQ5-90P-I MV5-90P-I
		Price	D3	D3	D3			D1
Hellige / Siemens Hörmann / Bosch								
		10	E10-HL-B E10R-HL-B	E10-HL-N E10R-HL-N	E10-HL-P E10R-HL-P	E10-HL	MQ10-LB	MQ10-LN
		10	E10-HL-B/I E10R-HL-B/I	E10-HL-N/I E10R-HL-N/I	E10-HL-P/I E10R-HL-P/I	E10-HL/I	MQ10-LB/I	MQ10-LN/I
		Price	D3	D3	D3	D3	D1	D1

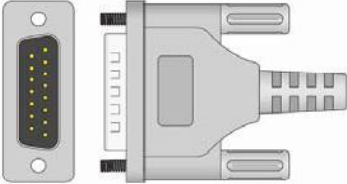
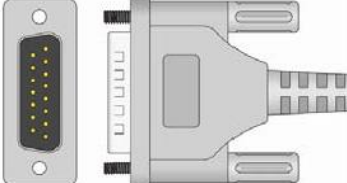
Kenz								
103,106 CARDIOLINE (Italy)		10	E10-KZ-B E10R-KZ-B	E10-KZ-N E10R-KZ-B	E10-KZ-P E10R-KZ-P	N/A	N/A	N/A
		10	E10-KZ-B/I E10R-KZ-B/I	E10-KZ-N/I E10R-KZ-N/I	E10-KZ-P/I E10R-KZ-P/I	N/A	N/A	N/A
		Price	D3	D3	D3			
Mortara								
ELI-200 ELI-50		10	E10-MT-B E10R-MT-B	E10-MT-N E10R-MT-N	E10-MT-P E10R-MT-P			
		10	E10-MT-B/I E10R-MT-B/I	E10-MT-N/I E10R-MT-N/I	E10-MT-P/I E10R-MT-P/I			
		Price	D3	D3	D3			
Nihon Kohden								
CaduFax 6151,6851,6353 CadioFax 8110		10	E10-NK1-B E10R-NK1-B	E10-NK1-N E10R-NK1-N	E10-NK1-P E10R-NK1-P	N/A	N/A	N/A
		10	E10-NK1-B/I E10R-NK1-B/I	E10-NK1-N/I E10R-NK1-N/I	E10-NK1-P/I E10R-NK1-P/I	N/A	N/A	N/A
		Price	D3	D3	D3			
CaduFax Q ECG-9110K ECG-9130K Doing Juang Cardioline (New)		10	E10-NK2-B E10R-NK2-B	E10-NK2-N E10R-NK2-N	E10-NK2-P E10R-NK2-P	N/A	N/A	N/A
		10	E10-NK2-B/I E10R-NK2-B/I	E10-NK2-N/I E10R-NK2-N/I	E10-NK2-P/I E10R-NK2-P/I	N/A	N/A	N/A
		Price	D3	D3	D3			







Philips/HP		HP BTL / Innomed / Biocare / Mortara / Aspel / Dr .Lee / Cardiette						
M1770A,M1771A,M1772 A Pagewrite100/200/200i		10	E10-HP-B E10R-HP-B	E10-HP-N E10R-HP-N	E10-HP-P E10R-HP-P	N/A	N/A	N/A
		10	E10-HP-B/I E10R-HP-B/I	E10-HP-N/I E10R-HP-N/I	E10-HP-P/I E10R-HP-P/I	N/A	N/A	N/A
		Price	D3	D3	D3			
	10-lead ECG monitoring		Fixed Snap	Fixed grabber	Trunk cable	ECG Yoke	Snap lead	Grabber lead
	12	HP-21085S	HP-21085P	HP-21085		HPA5-90S HPB5-90S	HPA5-90P HPB5-90P	
	12	HP-21085S-I	HP-21085P-I	HP-21085-I		HPA5-90S-I HPB5-90S-I	HPA5-90P-I HPB5-90P-I	
	Price	D3	D3	D3		D1	D1	
Schiller								
AT1, AT2, AT2 Plus,AT4 Resistor 10K Long Screw		10	E10-SH1-B E10R-SH1-B	E10-SH1-N E10R-SH1-N	E10-SH1-P E10R-SH1-P	N/A	N/A	N/A
		10	E10-SH1-B/I E10R-SH1-B/I	E10-SH1-N/I E10R-SH1-N/I	E10-SH1-P/I E10R-SH1-P/I	N/A	N/A	N/A
		Price	D3	D3	D3			
AT3,AT6,CS6,AT5, AT10,AT60 Short Screw		10	E10-SH2-B E10R-SH2-B	E10-SH2-N E10R-SH2-N	E10-SH2-P E10R-SH2-P	N/A	N/A	N/A
		10	E10-SH2-B/I E10R-SH2-B/I	E10-SH2-N/I E10R-SH2-N/I	E10-SH2-P/I E10R-SH2-P/I	N/A	N/A	N/A
		Price	D3	D3	D3			



Spacelabs								
12-lead ECG monitoring		Fixed Snap	Fixed grabber	Trunk cable	ECG Yoke	Snap lead	Grabber lead	
	12	SL-21096S	SL-21096P	MQ-21096		MQ5-90S	MQ5-90P	
	12	SL-21096S-I	SL-21096P-I	MQ-21096-I		MQ5-90S-I	MQ5-90P-I	
	Price	D3	D3	D3		D1	D1	

ECK accessories

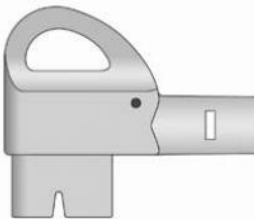
Product	Limb Clamps		Suction Electrode	
Photo				
Descriptions	Adult/universal ,3mm/4mm	Pediatric/universal ,3mm/4mm	Adult/universal ; ,3mm/4mm	Pediatric/universal ,3mm/4mm
Package	4 pcs/pack	4 pcs/pack	6 pcs/pack	6 pcs/pack
Color	Red/black/green/yellow, IEC	Red/black/green/yellow, IEC	Blue	Green
REF	UU-LC-A	UU-LC-P	UU-SE-A	UU-SE-P
Price	B6	B6	B8	B8
Photo				
Descriptions	Adult/universal ,3mm/4mm	Pediatric/universal ,3mm/4mm	Adult blue bulb ball	Pediatric green bulb ball
Package	4 pcs/pack	4 pcs/pack	6 pcs/pack	6 pcs/pack
REF	UU-LC-AA	UU-LC-PA	Y05-F021	Y05-F022
Color	All in green	All in green	Blue	Green
Price	B6	B6	A8	A8

Product	Adaptor wire			
Photo				
Descriptions	Adaptor wire, 0.3m 4mm/banana>>snap	Adaptor wire, 0.3m 4mm/banana>>grabber	Adaptor wire, 0.3m 3mm/needle>>snap	Adaptor wire, 0.3m 3mm/needle>>grabber
Package	10 pcs/pack	10 pcs/pack	10 pcs/pack	10 pcs/pack
REF	AD-B-S	AD-B-P	AD-N-S	AD-N-P
Price	B8	B8	B8	B8
Photo				
Descriptions	Flat clip, Red For 4mm/banana and electrode nut	Flat clip, Blue For 3mm/needle and electrode nut	Alligator clip, Red/gray For 4mm/banana	Alligator clip, Blue/gray For 3mm/needle
Package	10 pcs/pack	10 pcs/pack	10 pcs/pack	10 pcs/pack
REF	AD-BF-10	AD-NF-10	AD-BA-10	AD-NA-10
Price	B7	B7	B7	B7
	 AD-BF	 AD-NF	 AD-BA	 AD-NA

EKG LEAD	Lead wire/5X2-lead,0.9m	Lead wire/10-lead,0.9m/1.2m	Lead wire #1/5-lead,0.9m	Lead wire #2 /5-lead,0.9m
Picture				
Brand	GE Marquette(Brown)	(Gray)	Philips Medical(Blue Conn.)	(Red Conn.)
Snap/AHA	MV5-90S	MQ5-90S	HPA5-90S	HPB5-90S
Grabber	MV5-90P	MQ5-90P	HPA5-90P	HPB5-90P
Snap/IEC	MV5-90S-I	MQ5-90S-I	HPA5-90S-I	HPB5-90S-I
Grabber	MV5-90P-I	MQ5-90P-I	HPA5-90P-I	HPB5-90P-I
Price	C2	C2	C2	C2
EKG LEAD	Lead wire/10-lead, 0.9m/1.2m		Lead wire/10-lead, 0.9m/1.2m	
Picture				
Brand	Philips/AHA	Philips/IEC	Norav/AHA	Norav/IEC
Banana/4mm	PW10-LB	PW10-LB/I	AA10-LB	AA10-LB/I
Needle/3mm	PW10-LN	PW10-LN/I	AA10-LN	AA10-LN/I
Grabber	PW10-LP	PW10-LP/I	AA10-LP	AA10-LP/I
Snap	PW10-LS	PW10-LS/I	AA10-LS	AA10-LS/I
Price	D1	D1	D1	D1

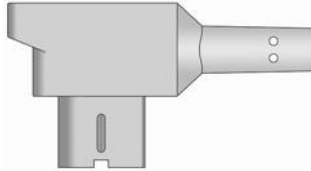
EKG LEAD	Lead wire(2X5-lead,0.9/1.2m)		Lead wire/10-lead, 0.9m/1.2m	
Picture				
Brand	GE Marquette/AHA	GE Marquette/IEC	GE Marquette/AHA	GE Marquette/IEC
Banana/4mm	MQ10-LB	MQ10-LB/I	MQD10-LB	MQD10-LB/I
Needle/3mm	MQ10-LN	MQ10-LN/I	MQD10-LN	MQD10-LN/I
Grabber	MQ10-LP	MQ10-LP/I	MQD10-LP	MQD10-LP/I
Snap	MQ10-LS	MQ10-LS/I	MQD10-LS	MQD10-LS/I
Price	D1	D1	D1	D1

Siemens/Drager MultiMed Cable



Compatibility: Major brands ECG or multi-parameter monitoring system

Compliance with
ANSI/AAMI EC53: 1998
EN 60601-1:1990
ISO10993-1,5,10: 2003E

FDA 510K clearance

Part number	Descriptions	Package	Cable plug	Price
SM-STE5 (3368391) For Siemens 6000 7000 9000 Drager Vista,	Multimed Pod patient cable, 2.5m Spo2 Temp 5-lead ECG, VS/Siemens AHA & IEC	1pcs		D8